

Looking after your stairlift

Model: **260 Siena**



Stannah



Ask any one in our team and they'll say they're committed to providing the best stairlifts. And they're true to their word.

Here at Stannah, our people are at the heart of everything we do. No matter what their role, they share our passion for making world class stairlifts.

Whether they are responsible for fitting a particular part or checking each finished stairlift as it glides off the production line, each one takes enormous care to ensure that every small detail is perfect. This commitment and pride is inspired by the way they see our customers - as individuals. Each employee understands that you need to have complete faith that your stairlift will work exactly as it should, so it can be everything you hope for.

It's this personal involvement, along with our policy of making every stairlift to order in our own Stannah facilities, that ensures that every model that leaves our premises is as good as it can possibly be. And there's one vision that drives all these principles - the Stannah pledge to be true to our word.

Everyone who works for us believes in what we stand for and is committed to fulfilling our promise to you - to provide you with a stairlift that offers all the quality, reliability and performance you need to stay comfortable, safe and independent in your home.

Service Log

It is important to us that our stairlifts always help you travel up and down your stairs in the safest possible way. With this in mind, we recommend our stairlifts are serviced every year by a Stannah trained service engineer.

Installed by _____ on / /

Position of wall switch _____

Date	Service details	Service Engineer
------	-----------------	------------------

_____	_____	_____
_____	_____	_____
_____	_____	_____
_____	_____	_____
_____	_____	_____
_____	_____	_____
_____	_____	_____
_____	_____	_____
_____	_____	_____
_____	_____	_____
_____	_____	_____
_____	_____	_____
_____	_____	_____
_____	_____	_____
_____	_____	_____
_____	_____	_____
_____	_____	_____
_____	_____	_____
_____	_____	_____
_____	_____	_____
_____	_____	_____
_____	_____	_____

A stairlift is a device to transport a seated person up and down the stairs safely

Welcome to your Siena User Guide.

To help you get the most from your new stairlift, please take a few minutes to read this guide. Then, please keep this guide in a safe place in case you need to check any details in the future. If you feel unsure about any aspect of your stairlift, please do not hesitate to get in touch with your stairlift supplier, details on the back page.



Siena

Thank you for choosing Stannah

Contents

Getting to know your stairlift	6-9
Using your stairlift	10
Power key	10
Remote calling control	11
Unfolding the chair	12
Hinged rail	13
Seatbelt	14
Arm control	15
Swivelling the seat	16
Getting off the stairlift	17
Cleaning your stairlift	18
Certification	19
Changing the batteries	20
Technical and Safety	22
HELP	24

Serial No: _____



You will find important safety information wherever you see the **SAFETY NOTICE** symbol shown above.

Important:
Your stairlift is not designed to operate in the event of a fire and should not be depended on as a means of escape.

Getting to know your stairlift

Siena stairlift

shown in travelling position

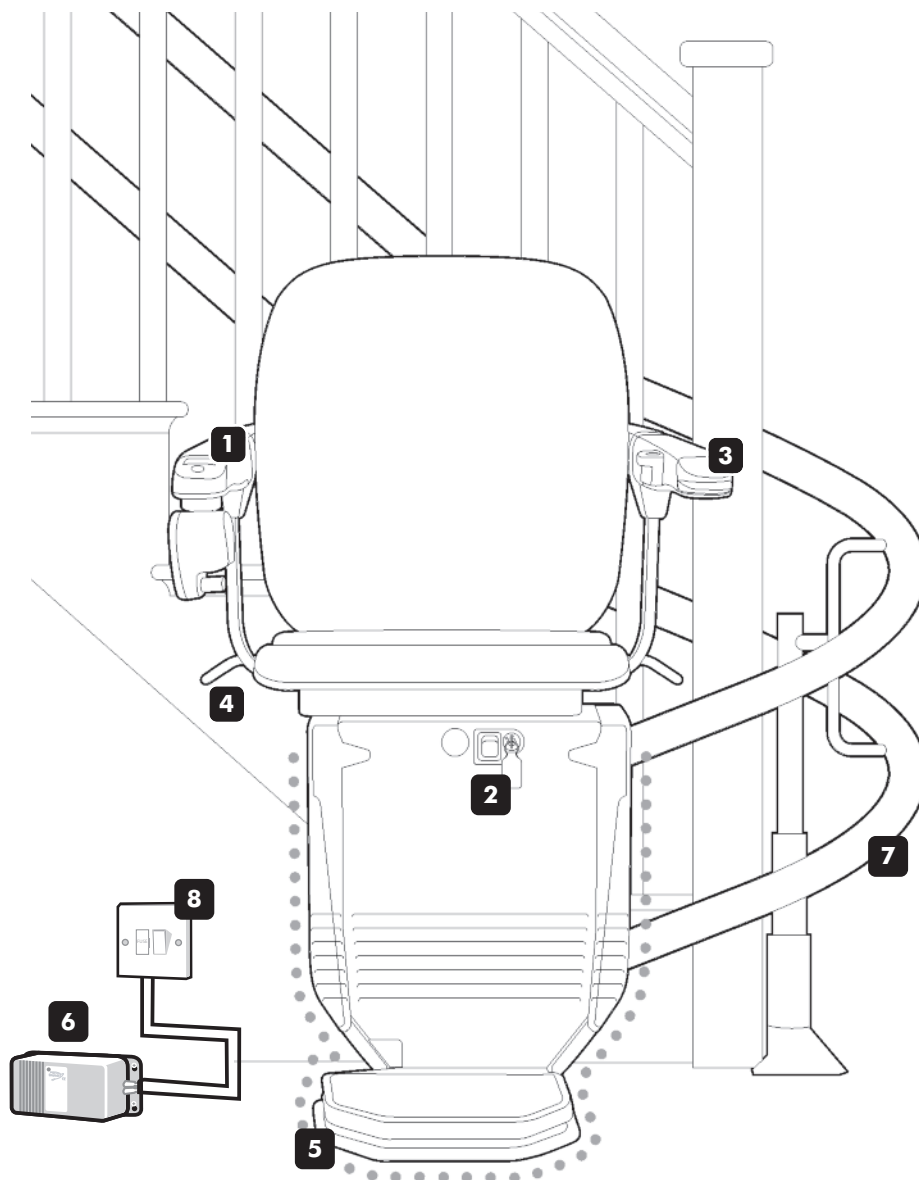

1 On/Off switch & power light

The power light comes on when the switch is in the on position.

2 Power key

The keyhole is on the front of the chair. The key must be inserted and turned to the on position before the stairlift will work – see page 10.

Please note that you can remove the power key to stop others from using your stairlift.

3 Arm Control

The arm control moves the stairlift in the direction you want to travel. If your chair has an automatic swivel seat, you can also use the control to swivel the seat.

4 Swivel levers

These are on both sides of the seat. The seat will swivel outwards at the top of the stairs to help you get on or off the stairlift.

5 Safety edges

The safety edges are there to stop the stairlift if they come into contact with any obstacles. This stops anything from becoming trapped while the stairlift is being used. See page 24 for more information.

6 Battery charger

Charges the batteries so the stairlift is always ready to travel. This may be positioned at either the top or bottom of your staircase.

7 Rail

8 Wall switch

This should normally be left switched on. See page 9 for more information.

For the 'HELP' section see page 24

Getting to know your stairlift

Using your stairlift

Cleaning your stairlift

Changing the batteries

Technical

Help

Getting to know your stairlift

Remote calling controls

Positioned at the top and bottom of the staircase, the remote calling controls let you call the stairlift if it is at the opposite end of the staircase to you.

The controls will not work unless the power key is turned to the on position.

The controls are battery powered. You will find information on how to change the battery on page 20.

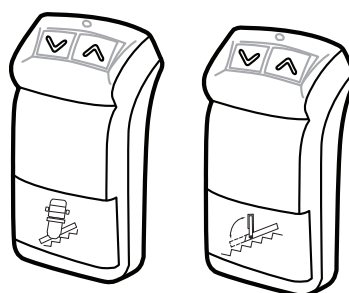
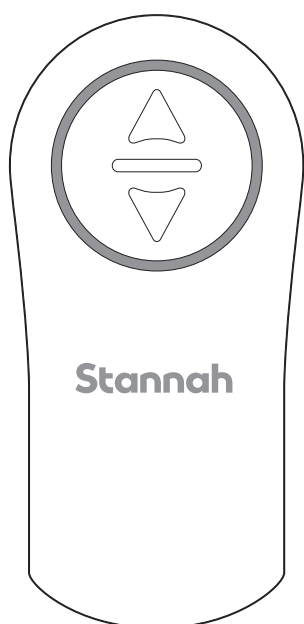

If you have a hinged rail, your remote calling controls will look like this. You will also have an additional control for your hinge. All controls have clear labels on the front so you can distinguish them from each other.



SAFETY NOTICE

Make sure no one else is using the stairlift before you call it using the wall mounted calling controls. Multi-users, see Page 25.

Master power switch and wall switch

The master power switch is on the front of the chair and should normally be left switched on.

The stairlift will not work if this switch is off.

If you are going away for a longer time – perhaps if you go away on holiday – you can switch off the master power switch and the wall switch.

*Make sure that you switch off **both** the master power switch and the wall switch – this will ensure that the batteries will still be charged when you return.*

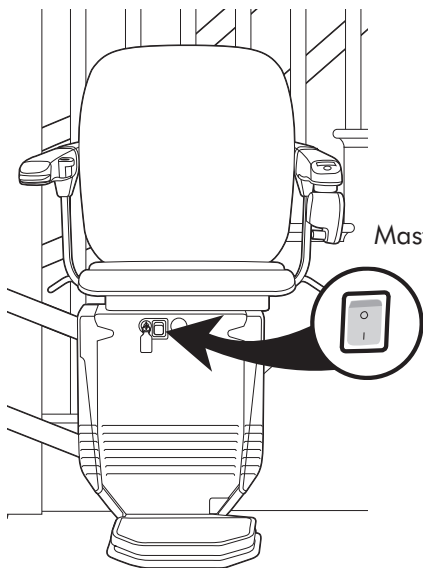

Options

You may have chosen from the range of options we provide for the Siena stairlift.

The options we've listed below are all covered in this guide, but if you need more information about any options that are not covered, please contact your local Stannah supplier.

Swivel seats

- Manual swivel seat.
- Automatic swivel seat.

Hinged rail

- Powered hinged rail.

Seatbelt

- Immobiliser seatbelt.

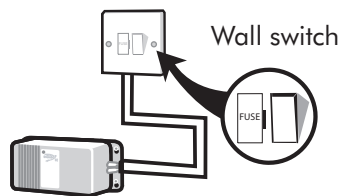

For the 'HELP' section see page 24

Using your stairlift

1. Turn on the power key

To turn on the power

Insert the key into the keyhole on the front of the chair.

Switch the on/off switch to the ON position.

The stairlift and the remote controls will not work unless you have inserted the power key.

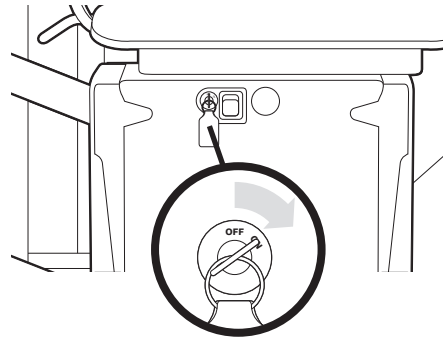

When the key and the on/off switch are in the on position, the light on the on/off switch will come on.

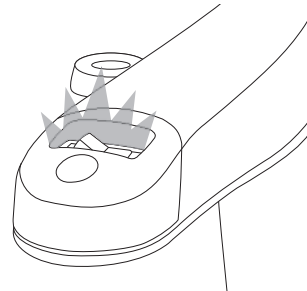

To switch off the power

Turn the on/off switch to the OFF position.

The light will go off.

If you do not want to remove the key, it can be left inserted as shown.

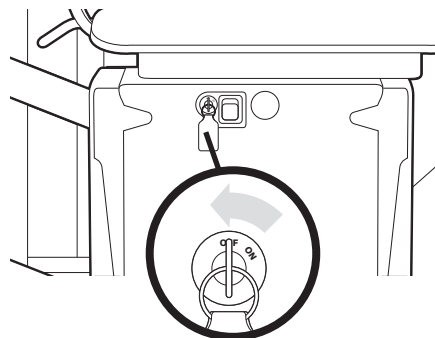

SAFETY NOTICE

You can remove the power key to stop others from using your stairlift

Using your stairlift

Using the remote calling controls

Use these when you want to move the stairlift to the opposite end of the stairs.

To move the stairlift along the rail

Press and hold the arrow button on the remote calling control to move the stairlift in the direction you want. You can move the stairlift whether the chair is folded or unfolded.

There is information on how to unfold the chair on page 12.

If you release the arrow button, the stairlift will stop and will not start again for a few seconds. Wait for a few seconds before starting the stairlift again.

Battery status

When you press one of the arrow buttons, the light on the control shows how much power is in the battery.

The batteries will last about one year with average usage.

You will find information on how to check and change the batteries on page 20.

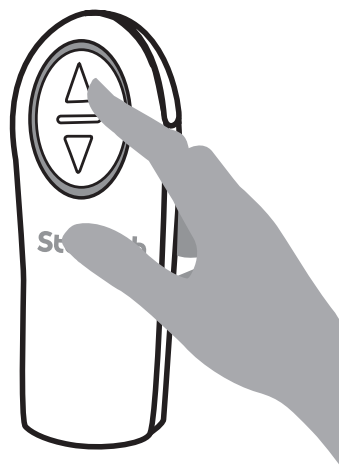

If you have a hinged rail, your remote calling controls will look like this.

For the 'HELP' section see page 24

Using your stairlift

2. Unfold the chair

Your chair can be folded away when it is not in use to give you more space around the top and bottom of your stairs.

To unfold the chair

To lower the footrest, use the lever on the side of the chair. Then lower both armrests and the seat.

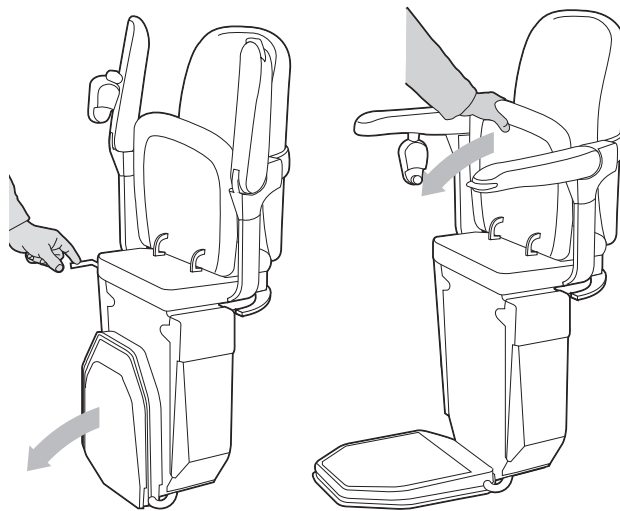

Footrest fold button (Optional)

If you have a footrest fold button you can use this to lower the footrest on its own.

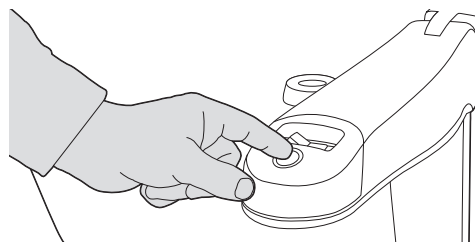

SAFETY NOTICE

Stand with your feet clear of the footrest when you lower the seat.

Using your stairlift

Using the hinged rail (optional)

Your stairlift may be fitted with a hinged rail that you can raise so the rail does not obstruct any doorways or passageways.

Note that the stairlift will not work until the hinged rail is fully lowered.

To use the powered hinged rail

Always make sure the chair is at the top of the stairs. Press and hold the arrow button on the hinged rail remote calling control until the hinge is fully raised or lowered.

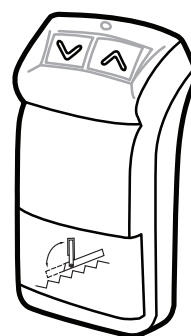

Please note that a light will flash and you will hear a series of beeps to warn you and others that the hinged rail is moving.

When you are at the bottom of the stairs, you will need to move the stairlift back up the stairs so that the hinged rail does not obstruct any doorway or passageways. This will also make sure that the stairlift is on charge.

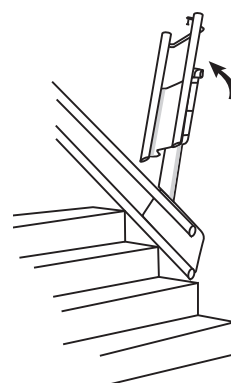

Press and hold the 'up' arrow on the hinged rail remote calling control until the hinged rail is fully raised.

Please note that if you leave the stairlift at the bottom of the stairs, it will start to beep. This is to warn you that your stairlift may cause an obstruction and that it is not on charge.



SAFETY NOTICE

Take care when raising or lowering the hinged rail

Using your stairlift

3. Settle into the seat and start the stairlift

Make sure the on/off switch is in the off position and the power light is off. Then, settle yourself into the seat, and put your seatbelt on.

When you are ready to travel up or down the stairs, switch the on/off switch to the on position, and use the arm control to start the stairlift.

To use the seatbelt

Pull the seatbelt across your lap and click into the holder.

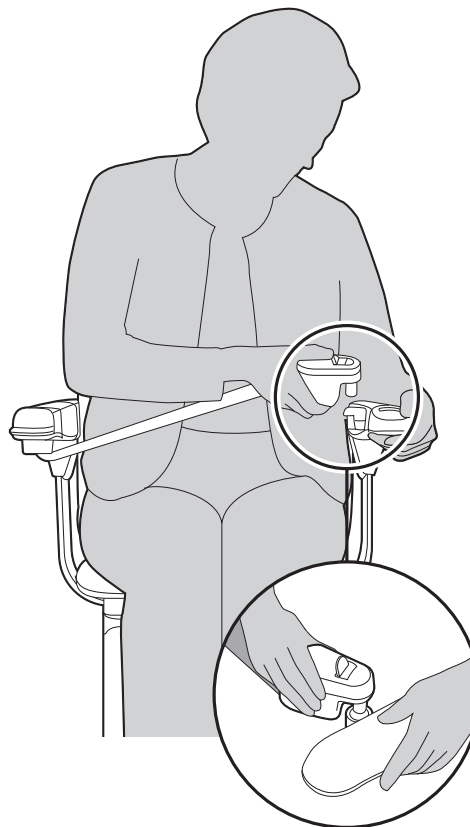

Immobiliser seatbelt (Optional)

If you have an immobiliser seatbelt, your stairlift will not start until you have put your seatbelt on.



SAFETY NOTICE

Always use the seatbelt. Only undo it when you have reached the top or bottom of the stairs and are ready to get off. Keep your elbows tucked in close to your body when using the stairlift.

Using your stairlift

To use the arm control

Move and hold the arm control in the direction you want to travel – after a few seconds the stairlift will start. The delayed start is a safety feature.

When the stairlift has reached the top or bottom of the stairs, it will stop. If you release the arm control at any point, the stairlift will stop.

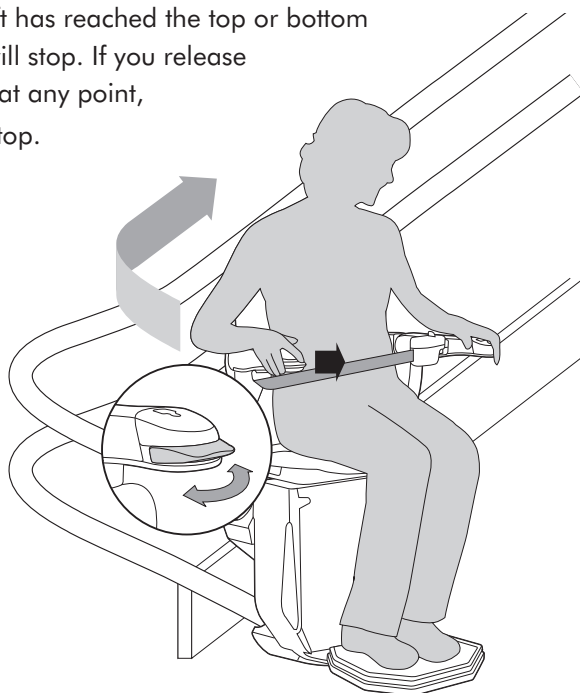

Automatic swivel seat (optional)

If you have an automatic swivel seat, you can continue to hold the arm control when you have come to the end of your journey and the seat will automatically swivel to the side. See page 16.

Please note that after the stairlift has stopped, there will be a few seconds' delay until the seat swivels.



SAFETY NOTICE

Only one person should ever use the stairlift at one time.

Using your stairlift

4. Swivel the seat

At the top of the stairs you can swivel the seat to the side to help you get off the stairlift.

You can also swivel the seat to make it easier to get on the stairlift when you want to go back down.

To swivel the chair using the manual swivel seat

Lift the swivel levers on the side of the seat and swivel the seat to the side.

You can only do this in the direction of the top of the stairs – this is a safety feature.

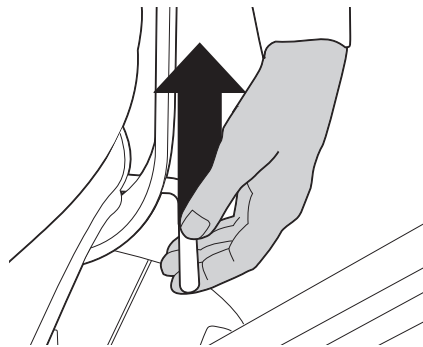

To swivel the chair using the automatic swivel seat

Push and hold the arm control in the direction you want to swivel the seat.

Two-way automatic swivel seat

If you have a two-way automatic swivel, you can swivel the seat at the top and bottom of the stairs.

Please note that if you have selected a two-way swivel seat, the stairlift will only swivel in the downwards direction when it is at the bottom of the stairs.

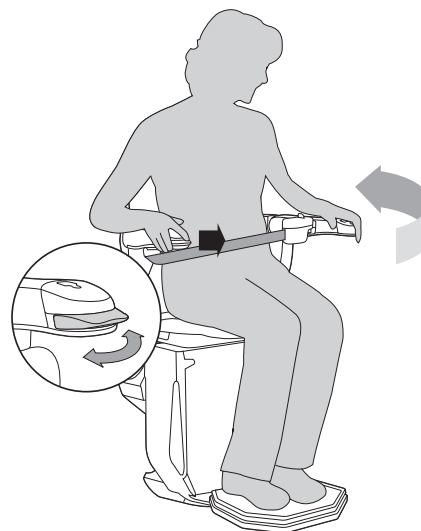

Using your stairlift

5. Get off the stairlift

Make sure the on/off switch is in the off position and the power light is off. Carefully, get off the stairlift and swivel the seat back to its travelling position. You can fold the chair away if you wish.

To get off

Unfasten the seatbelt.

Slide the button towards the armrest and lift the clip out of the holder. Carefully, get off the stairlift.

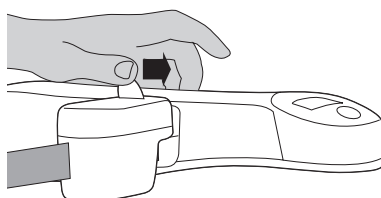

Swivel the seat back to its travelling position using either the manual swivel levers or, if you have an automatic swivel, the remote calling controls. You can fold the chair away if you wish.

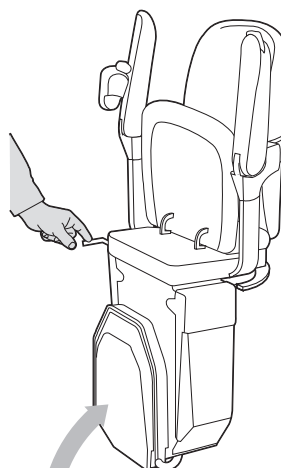

Footrest fold button (Optional)

If you have a footrest fold button you can use this to raise the footrest on its own.

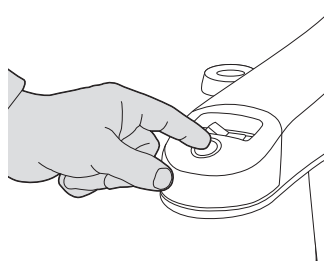

For the 'HELP' section see page 24

Cleaning your stairlift

If there are any aspects of cleaning your stairlift that you are unsure about, please call your Stannah supplier.

To clean the rail

Use a damp cloth to remove any dust or dirt.

To clean the upholstery

Use a damp cloth to remove any dust or dirt.

Do not use any solvent cleaners, bleaches, abrasives, synthetic detergents, wax silicone polishes or aerosol sprays without checking with your stairlift supplier first.

Further Information

Angle	Weight limit
Up to 52°	135kg (approx 21 stone)

Maximum sound emissions 70dB

Battery charger input: 100 - 240V AC 50/60 Hz Output to stairlift: 24V DC 750mA. Output to hinged rail: 12V DC 140 mA



Recycling and disposal of your stairlift

Do not dispose of any part of this product as everyday rubbish. For more information about recycling and disposal of your stairlift, please contact your Stannah supplier, details on the back page.

Stannah

EC DECLARATION OF INCORPORATION

Stannah Stairlifts Limited
Watt Close, East Portway, Andover,
Hampshire, England SP10 3SD

We hereby declare that the machinery listed below complies with all the applicable essential health and safety requirements with **Annex I of the Machinery directive 2006/42/EC** and the relevant technical documentation is compiled in accordance with **part B of Annex VII** of this directive:-

The machinery also complies with the following directives

Low Voltage Directive 2006/95/EC
EMC Directive 2004/108/EC

Stannah Stairlift Model 260
Incorporating the following manual or powered swivelling chairs
(Siena, Sadler, Starla, Solus, Sofia, Sarum, Saxon) and
the powered hinged rail

“To conform with the provisions of the Machinery directive the machinery must not be put into service until the product has been installed and commission tested in accordance with Stannah Stairlifts Ltd installation instructions”

The Technical Documentation has been compiled by
Steve Leathley (Engineering Director)

Where required in response to a reasoned request by national authorities,
relevant information on this machinery can be provided

Signed:

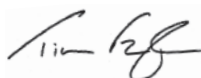

Date: 30th April 2012 Place: Stannah Stairlifts, Andover

Tim Eagles
(Joint Managing Director)

Being the person empowered to draw up the declaration on behalf of the manufacturer

Getting to know your stairlift

Using your stairlift

Cleaning your stairlift

Changing the batteries

Technical

Help

Changing the battery on the remote calling control

The remote calling control batteries will last about one year with average use.

When you press one of the arrow buttons, the light around the buttons will tell you how much power is in the battery.

Lights rotating	<i>Batteries OK</i>
Lights on constantly	<i>Batteries low on power – change batteries as soon as possible</i>
No light	<i>Batteries have no power</i>

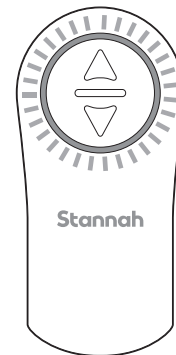

The lights are on constantly when the battery is low.

If you have a hinged rail, the light on your remote calling control will work differently as follows:

Green light on	<i>Batteries OK</i>
Green light flashing	<i>Batteries low on power – change batteries as soon as possible</i>
No light	<i>Batteries have no power</i>



The green light is flashing when the battery is low.

To change the battery

Remove screw, slide down and open the battery cover, then insert the new batteries.

Each remote calling control takes three AA batteries.

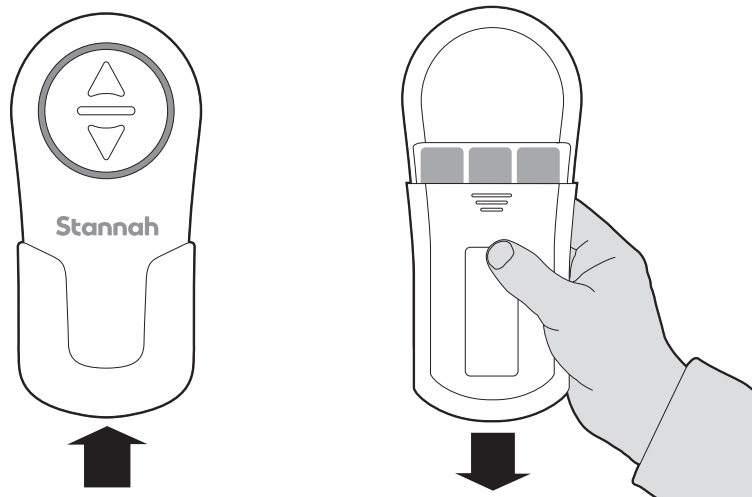

If you have a hinged rail, the battery compartment on your remote calling control is different.

Open the battery cover and insert a new 9V PP3 battery.

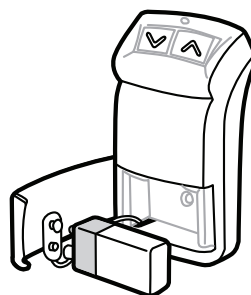

For the 'HELP' section see page 24

Getting to know your stairlift

Using your stairlift

Cleaning your stairlift

Changing the batteries

Technical

Help

Technical and Safety

It is very unlikely that your stairlift will stop whilst travelling. However, if it does and is causing an obstruction, we have provided you with a hand-winding tool and instructions on how to manually move your stairlift out of the way.

If your stairlift stops at the end of the rail and the power light on the armrest goes off, use the checklist on page 24. If the checklist does not help you to solve the problem, please follow the instructions below. If in any doubt, please contact your Stannah supplier for help. Details are on the back page.

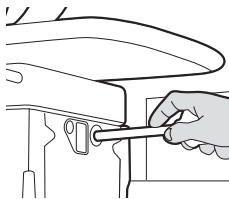

To move the stairlift using the hand-winding tool

Switch off the master power switch. See page 9.
Remove the plastic cap on the front of the chair base.
Put the hand-winding tool into the hole where labelled.
Turn the handle as shown on the label on the chair base

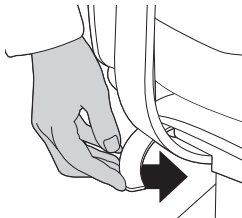

To swivel the automatic swivel seat

Switch off the master power switch.
Push both levers inwards
You can then swivel the chair until it is in its travelling position.













SAFETY NOTICE

Never use the stairlift when the hand-winding tool is in the hole

Technical and Safety

Follow these points to make sure you always use your stairlift safely.

-  Make sure no one else is using the stairlift before you call it using the remote calling controls.
-  You can remove the power key to stop others from using your stairlift.
-  Stand with your feet clear of the footrest when you lower the seat.
-  Make sure the area around the hinged rail is clear before moving the stairlift.
-  Always use the seatbelt. Only undo it when you have reached the top or bottom of the stairs and are ready to get off.
-  Keep your elbows tucked in close to your body when using the stairlift.
-  Only one person should ever use the stairlift at any time.
-  Never use the stairlift when the hand-winding tool is in the hole.
-  Never allow children to use the stairlift unsupervised.
-  Never attempt to dismantle the stairlift.
-  If you are home alone when using your stairlift, we recommend carrying a mobile telephone, or some other communication device, so you can alert others if you need help getting off the stairlift.

Help

It is unlikely that you will ever experience a problem with your stairlift. If you do, please use the following checklist.

If the checklist doesn't help you to solve the problem, contact your stairlift supplier, details on the back page.

Stairlift will not move

The power light is off

- Check that the master power switch is switched on – see page 9.
- Check that the power key is inserted and turned to the on position – see page 10.

The stairlift will not work if either of these are switched off.

The power light is on

- Check that the chair is swivelled back to its travelling position and that the swivel levers are fully pushed down.
The chair will not move unless it is in this position – see pages 6 and 15.

- Check whether there is anything obstructing the safety edges –

If there is, the stairlift can be moved in the opposite direction to allow you to remove the obstruction. You can then continue to go up or down the stairs.

If you have the optional powered hinged rail,

- Check that the hinged rail is fully lowered.

If your stairlift still does not move

(1) turn the power key to the off position, then back on.

(2) move and hold the control in the downward direction – after a few seconds the stairlift will start. Then call your Stannah supplier.

If the stairlift stops during the above, repeat steps 1 and 2 until you reach the bottom of the stairs.

If steps 1 and 2 do not work, then alert another person in the home and ask them to contact your Stannah supplier.

If you are home alone when using your stairlift, we recommend carrying a mobile telephone, or some other communication device, so you can alert others if you need help getting off the stairlift.

As a last resort, swivel the chair towards the top of the stairs, undo seatbelt and exit up the stairs. Then call your Stannah supplier.

Help

Stairlift is beeping

The batteries are not being charged. Please note that your stairlift can continue to run on battery power.

- Check that the wall switch is on. *The position of the wall switch can be found on page 9 of this guide.*
- Check that there has not been a power cut.
- Check that the stairlift is at the top or bottom of the stairs.

If you cannot correct the fault, you can switch off the beeper by turning the master power switch to the off position – see page 9. Then, please call your Stannah supplier.

Multiple occupancy buildings

- Switch off the power key before getting into and out of the chair. This will ensure that no one else can call the stairlift when you are using it.
- Make sure the power key is turned to the on position when you have completed your journey. This ensures the stairlift will work for other users.

Remote calling controls do not work

- Check the batteries – see page 20.

Automatic swivel seat does not work

- Please call your stairlift supplier. *Use the standard swivel levers to swivel your stairlift – see page 16.*

Optional powered hinged rail does not work

Please call your stairlift supplier.

- *If the hinged rail is causing an obstruction, you can raise the rail manually using the underside of the rail – see picture.*

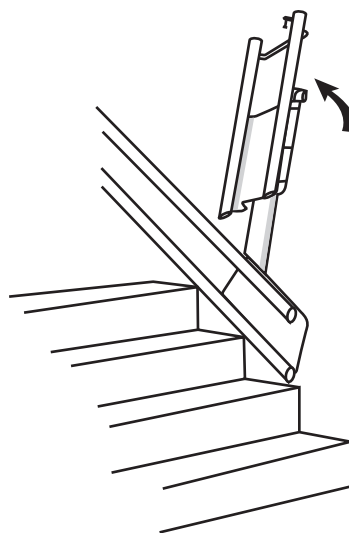

Help

Product Labelling

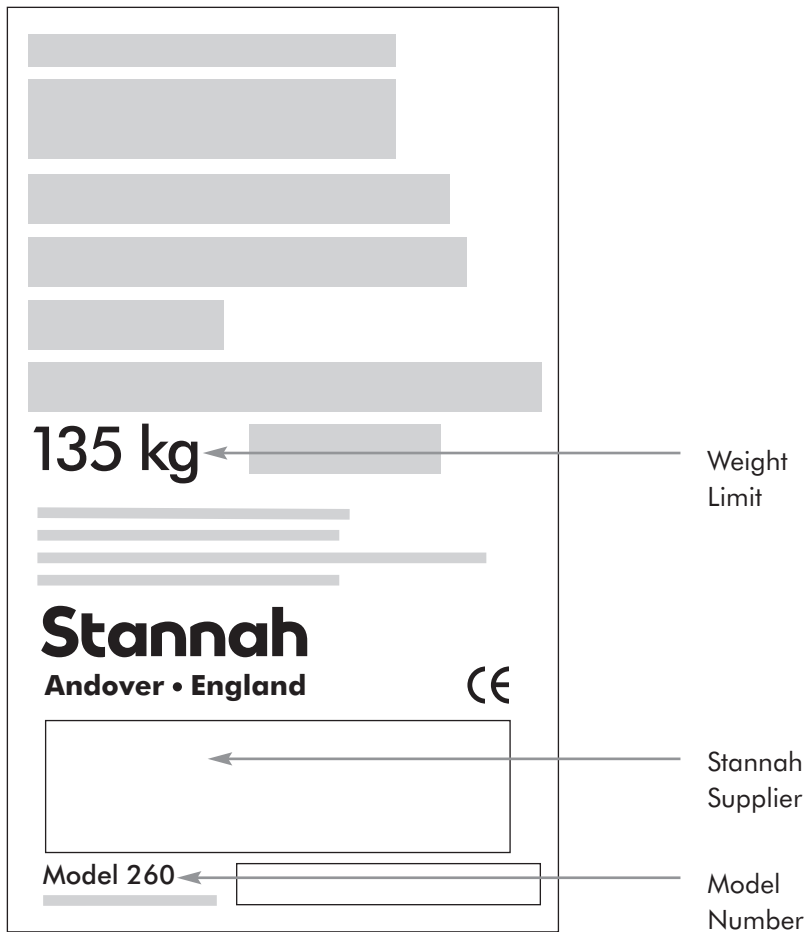

**We're here to help, everyday
and everywhere.**

**At Stannah we know our business
isn't just about stairlifts - it's about
you, too. That's why if you ever need
help, we're right there.**

In the unlikely event that you need help with your stairlift, we're never more than a phone call away. If you experience a problem and are unable to resolve it there's no need to worry - we're always ready to help. See details on the back page.

Contact Details

Stannah

Stannah Stairlifts, Watt Close, East Portway, Andover,
Hampshire, SP10 3SD, United Kingdom www.stannah.com

Issue 1 May 2012



600420

English

Original Instructions

